

Features

- 33-inch minimum base cabinet width.
- Acid-resistant enamel finish.
- Double (equal) bowl.
- Top-mount.
- Two faucet holes.
- 33" (838 mm) x 22" (559 mm)

Material

- KOHLER® enameled cast iron.

Recommended Accessories

- K-9000 P-Trap
- K-5133 Left-Bowl Sink Rack
- K-5135 Right-Bowl Sink Rack
- K-6539 Drainboard with Sink Rack
- K-6377 Sponge Caddy
- K-6378 Kitchen Brush Caddy
- K-6379 Kitchen Squeegee
- K-6382 Disinfecting Wipes Dispenser
- K-6383 Soap Dispenser
- K-8618 Paper Towel Holder
- K-8619 Flexible Kitchen Mat
- K-8624 Dish Scraper

Optional Accessories

- K-6016L Left-Bowl Sink Rack
- K-6016R Right-Bowl Sink Rack
- K-6545 Sponge Caddy
- K-6603L Sink Basket
- K-6603R Sink Basket
- K-8801 Sink Strainer

Components

- Product includes:
1054375 Under-mount Sink Kit, 23"



Codes/Standards









ASME A112.19.1/CSA B45.2

KOHLER® Enameled Cast Iron Kitchen Sink Lifetime Limited Warranty

See website for detailed warranty information.

Available Color/Finishes

Color tiles intended for reference only.

Color	Code	Description
	0	White
	FF	Sea Salt™
	96	Biscuit
	47	Almond
	FD	Cane Sugar™
	95	Ice™ Grey
	K4	Cashmere
	7	Black Black™

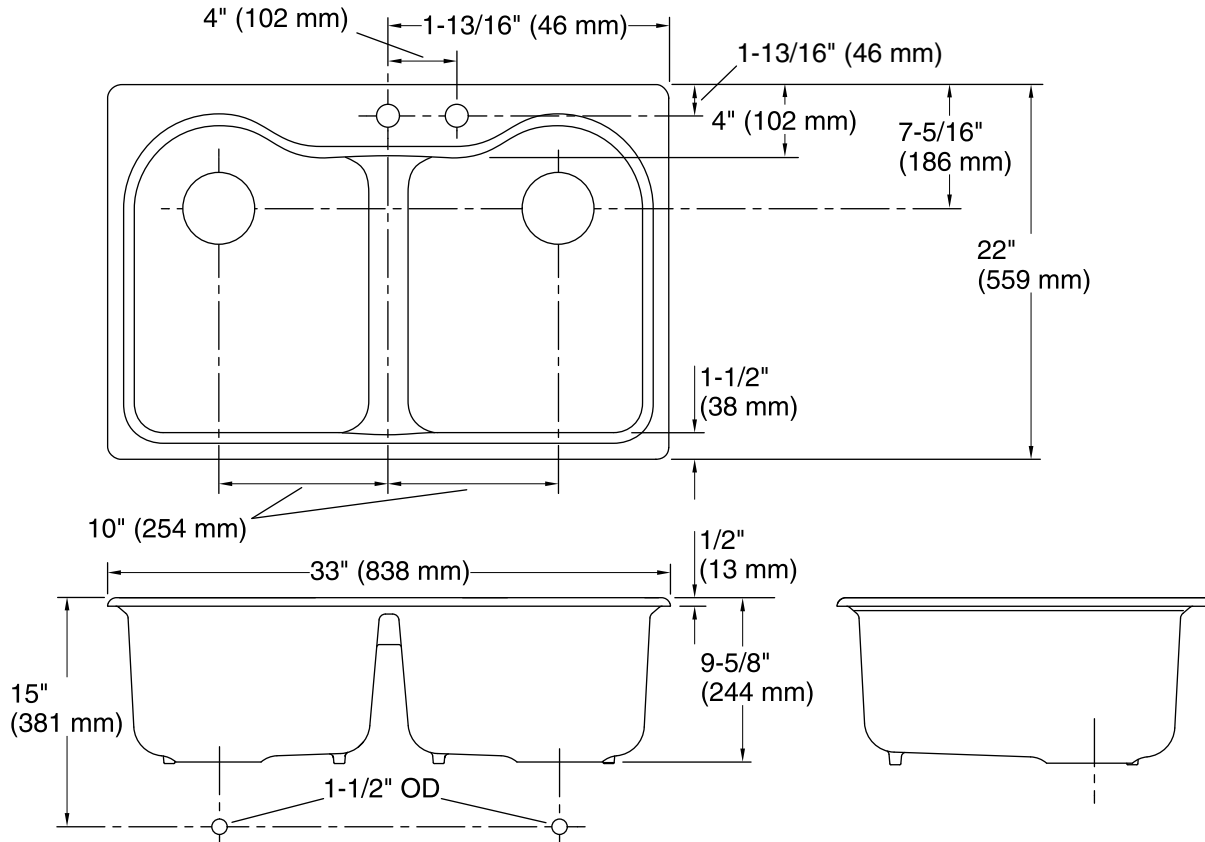

Technical Information

All product dimensions are nominal.

Bowl configuration:	Double equal
Installation:	Top-mount
Bowl area (Left):	Length: 14-1/8" (359 mm) Width: 16-1/4" (413 mm) Bowl depth: 9" (229 mm)
Bowl area (Right):	Length: 14-1/8" (359 mm) Width: 16-1/4" (413 mm) Bowl depth: 9" (229 mm)
Number of deck holes:	2
Faucet hole(s):	1-3/8" (35 mm)
Drain hole:	3-7/8" (98 mm)
Template:	1125670-7, required, included

Notes

Install this product according to the installation instructions.

NOTICE: The countertop manufacturer or cutter must use the cut-out template provided with the product, or a current one provided by the Kohler Co. (Call 1-800-4-KOHLER.) Kohler Co. is not responsible for cut-out errors when the incorrect cut-out template is used.