

Features

- Vanity-top.
- Oval basin.
- Without overflow.
- 8-inch centers.
- Combines with standard 36" (915 mm) x 22" (559 mm) vanities to create a complete sink.
- 37-5/8" (956 mm) x 22-1/4" (565 mm)

Material

- KOHLER® enameled cast iron.

Recommended Accessories

K-9018 P-Trap



Codes/Standards













ASME A112.19.1/CSA B45.2

Lifetime Limited Warranty for KOHLER® Cast Iron Components

See website for detailed warranty information.

Available Color/Finishes

Color tiles intended for reference only.

Color	Code	Description
	0	White
	FF	Sea Salt™
	96	Biscuit
	47	Almond
	FD	Cane Sugar™
	NY	Dune
	95	Ice™ Grey
	G9	Sandbar
	FT	Basalt
	20	Suede
	KA	Black 'n Tan
	7	Black Black™

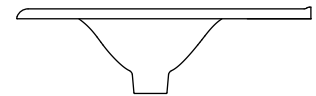
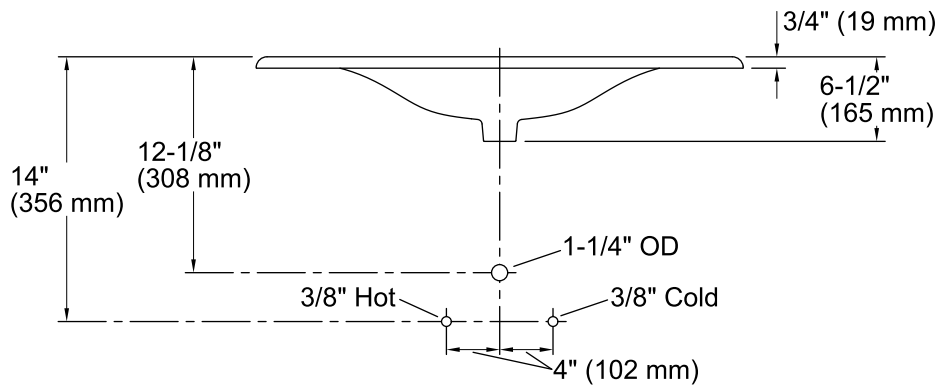
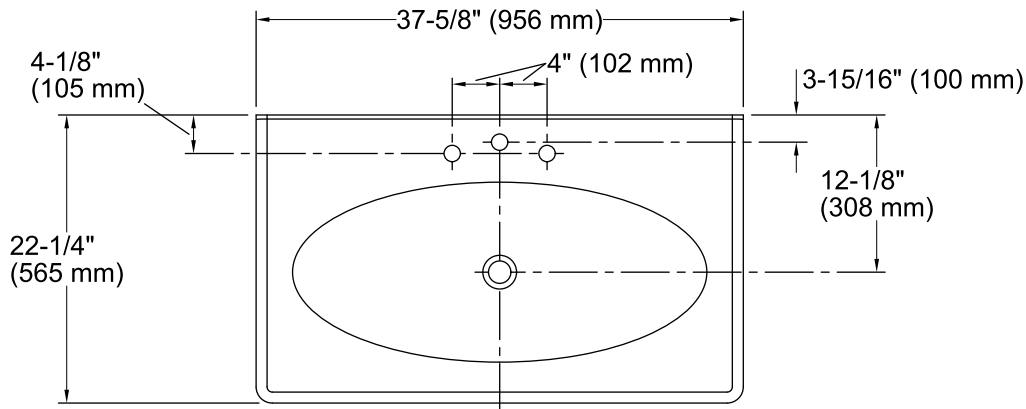

Technical Information

All product dimensions are nominal.

Bowl configuration:	Single
Installation:	ITB
Bowl area (Only)	Length: 32" (813 mm) Width: 13-7/8" (352 mm)
Number of deck holes:	3
Faucet hole(s):	1-3/8" (35 mm)
Drain hole:	1-3/4" (44 mm)

Notes

Install this product according to the installation instructions.

NOTE: When selecting a faucet for this bathroom sink, ensure the faucet has a spout reach of 4-1/2" (114 mm) to 5" (127 mm) and has a spout height of 3" (76 mm) to 6" (152 mm).

Product does not have an overflow.