



# Iron/Impressions®

## Vanity-top Bathroom Sink

### K-3049-1

#### Features

- Vanity-top.
- Rectangular basin.
- Without overflow.
- Single faucet hole.
- Combines with standard 30" (762 mm) x 22" (559 mm) vanities and 29" (737 mm) iron console tables.
- 31-5/8" (803 mm) x 22-1/4" (565 mm)

#### Material

- KOHLER® enameled cast iron.

#### Recommended Accessories

K-9018 P-Trap



#### Codes/Standards











ASME A112.19.1/CSA B45.2

#### Lifetime Limited Warranty for KOHLER® Cast Iron Components

See website for detailed warranty information.

#### Available Color/Finishes

*Color tiles intended for reference only.*

Color	Code	Description
	0	White
	FF	Sea Salt™
	96	Biscuit
	47	Almond
	FD	Cane Sugar™
	NY	Dune
	95	Ice™ Grey
	G9	Sandbar
	FT	Basalt
	KA	Black 'n Tan
	7	Black Black™

USA/Canada: 1-800-4KOHLER (1-800-456-4537)

Kohler Co. reserves the right to make revisions without notice to product specifications.

For the most current Specification Sheet, go to [www.kohler.com](http://www.kohler.com).

4-3-2018 03:55

THE BOLD LOOK  
OF **KOHLER**®

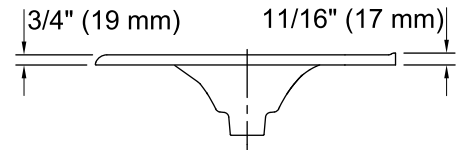
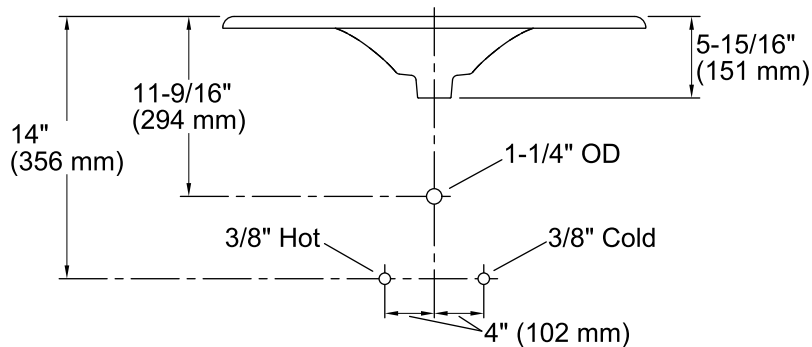
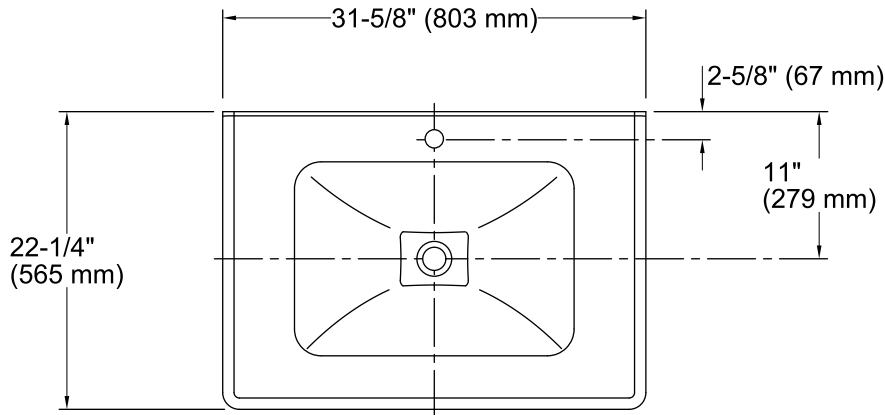

### Technical Information

All product dimensions are nominal.

Bowl configuration:	Single
Installation:	ITB
Bowl area (Only):	Length: 20-7/8" (530 mm) Width: 14-1/2" (368 mm) Water depth: 4" (102 mm)
Number of deck holes:	1
Faucet hole(s):	1-3/8" (35 mm)
Drain hole:	1-3/4" (44 mm)

### Notes

Install this product according to the installation instructions.

NOTE: When selecting a faucet for this bathroom sink, ensure the faucet has a spout reach of 4-1/2" (114 mm) to 5" (127 mm) and has a spout height of 3" (76 mm) to 6" (152 mm).

Product does not have an overflow.